

Dial-A-Chem

Mobile and Wall Mount Cleaning and Sanitizing System

The Dial-A-Chem combines the best of both worlds by creating the first all-in-one portable, self-contained foam cleaning and sanitizing system that delivers rich and consistent foam to any hard surface. The revolutionary new product allows for switching between foam, sanitizer, or rinse with a simple turn of the dial. The Dial-A-Chem is available in a wall mount or a mobile cart version. The Dial-A-Chem Mobile Cart allows the user to clean and sanitize multiple rooms with a single system with portability of the chemical concentrates.

**The Industries first all in One-Gun
cleaning and sanitizing system**

NEW



Dial-A-Chem Wall Mount

**Everything you need to
Foam, Sanitize, and Rinse
right in your hand!**



Dial-A-Chem
Mobile Cart

- No more walking back and forth or switching components with everything you need in your hand and all the controls at your fingertips
- With the Dial-A-Chem Wall Mount, the operator only carries the gun, while the chemical supply is left behind ensuring no worries of chemical running out in large areas
- The Dial-A-Chem Mobile Cart is exceptionally light and maneuverable with only the chemicals and Dial-A-Chem on the cart
- Rugged, long life design to withstand operator abuse and exposure to chemicals
- Up to 10 feet (3 m) of foam throw distance and fan spray sanitizing/rinse
- 16 dilution ratios ranging from 6:1 to 640:1 for dilution flexibility
- Immediate foam, sanitizer, or water dispensing with no residue left in the line when switching chemicals.

KNIGHT

IDEX
FLUID & METERING

INDUSTRIAL SYSTEMS

KNIGHT

Dial-A-Chem Wall Mount - Hose End Foamer

The Dial-A-Chem Wall Mount is an engineering innovation designed to make cleaning and sanitizing as simple and as easy as possible. Its revolutionary design enables the unit to accurately dilute the chemicals, draw the chemicals from 100 feet away to the Dial-A-Chem, and then mix the chemical with water before expelling a rich consistent foam. This allows the user to only have to carry the Dial-A-Chem, leaving the possible endless supply of chemical back in the storage area. The innovation doesn't end there, the Dial-A-Chem has the ability to switch between foaming, rinsing, and sanitizing with a twist of the dial on the gun making it the easiest operating cleaning and sanitizing system out there.

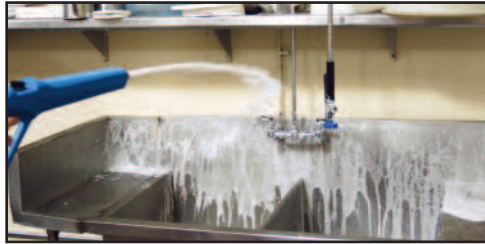

Features and Benefits

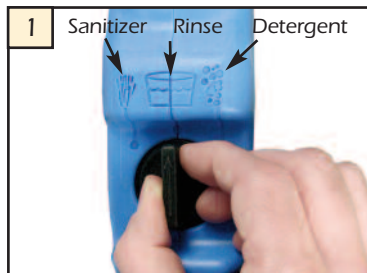
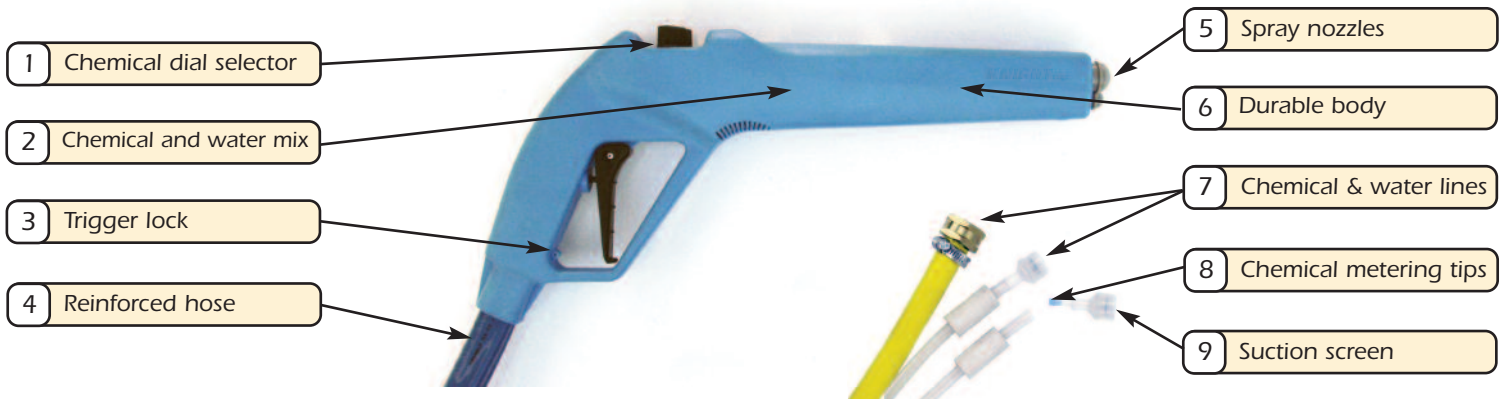

With a simple turn of the dial, switching from cleaning to rinse to sanitizing has never been quicker or easier.



The unique design provides immediate foam, sanitizer, or water dispensing. There is no waiting for previous chemical to clear the hose!



Lightweight design and the trigger lock on the handle allows for continuous dispensing with reduced operator exertion.



The Dial-A-Chem is available in a durable 25 ft. (7.6 m) or 50 ft. (15.2 m) or 100 ft. (30.4 m) reinforced hose to adapt and reach anywhere in the facility.



The Dial-A-Chem contains three independent nozzles designed to most efficiently spray out foam, sanitizer, or water. In less time with fewer passes

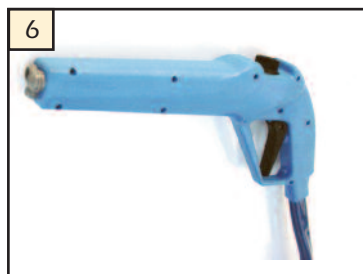

The Dial-A-Chem is extremely rugged and durable; capable of with standing extreme use. The Dial-A-Chem can withstand repeated drops on a concrete floor!

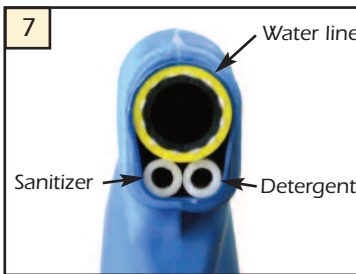

The water and chemicals are drawn independently in each tube inside the hose, which ensures immediate dispensing at the point of use.



Select from 16 dilution tips ranging from 6:1 to 640:1 or for additional ratios up to 757:1 use our tortuous path metering devices. Simply screw the tip onto the foot valve. The foot valve then is simply pushed onto the chemical line and you are ready to go.

Dial-A-Chem Mobile Cart

The Dial-A-Chem Mobile Cart offers the benefits of the standard Dial-A-Chem, but also has the ability to move from room to room. With the Dial-A-Chem and the chemicals contained on the cart, the Dial-A-Chem Mobile Cart is exceptionally light and maneuverable. Just connect the Dial-A-Chem Mobile Cart to a water source, and the cleaning and sanitizing system is ready to go. This mobile, self-contained system offers the freedom to clean a whole facility with just a single system without the need to refill containers with premixed chemicals.

Features



Bottle types

The Dial-A-Chem Mobile Cart can hold a variety of common bottle shapes and sizes to fit your needs. Custom bottle shapes available on request.

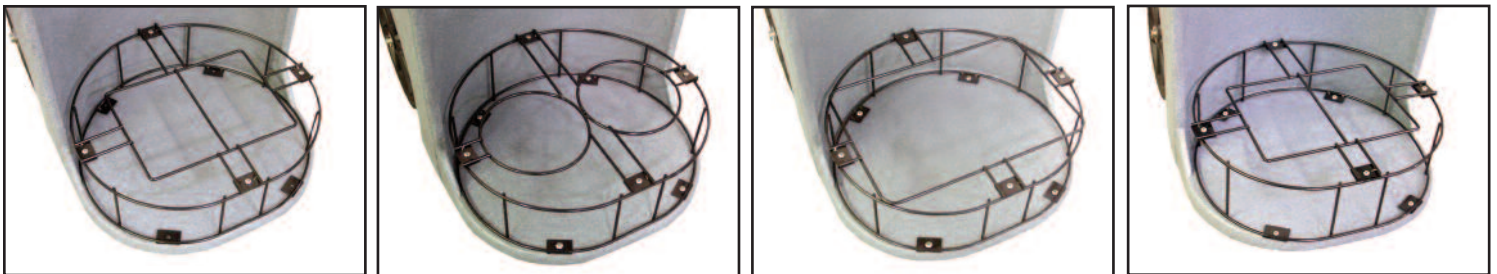

Rack for two 1 gallon F-Style

Rack for two 1 gallon round

Rack for two 2.5 gallon F-style

Rack for two 5 liter F-Style

Foam, Rinse, Sanitize Application



The Dial-A-Chem draws chemical with eductors and, then mixes the chemical with water inside the gun to create a high foam quality that can be thrown up to 10 feet (3 m).



With a simple turn of dial, the rinse nozzle sprays out in a V-shape spray to wash off the counters efficiently and quickly.



With 16 mixing ratios depending on the choice of colored metering tips, rest assured the exact concentration of sanitizer will be applied when the Dial-A-Chem sprays the sanitizer in a V-shape pattern.

Cleaning Applications

Metering Tip Chart



Restaurant



Restroom Facilities



Grocery Store



Fast Food



Showers



Small Food Plants

Metering Tip Chart									
Flowrate	Foam				Flowrate	Sanitizer			
	1 gallon	1 liter				1 gallon	1 liter		
Color	oz/gal	ml./lit.	ratio	%	Color	oz/gal	ml./lit.	ratio	%
None	20.9	163	6.1:1	16.3	None	18.9	147	6.8:1	14.7
White	19.6	153	6.5:1	15.3	White	17.6	137	7.3:1	13.7
Yellow	18.6	145	6.9:1	14.5	Yellow	16.9	132	7.6:1	13.2
Pink	15.6	121	8.2:1	12.1	Pink	15.6	121	8.2:1	12.1
Dk Green	12.2	95	10.5:1	9.5	Dk Green	12.2	95	10.5:1	9.5
Black	9.5	74	13.5:1	7.4	Black	9.5	74	13.5:1	7.4
Brown	7.4	57	17.3:1	5.7	Brown	7.4	57	17.3:1	5.7
Gray	5.1	39	25:1	3.9	Gray	5.1	39	25:1	3.9
Blue	4.1	32	32:1	3.2	Blue	4.1	32	32:1	3.2
Red	3.4	26	38:1	2.6	Red	3.4	26	38:1	2.6
Peach	2.7	21	48:1	2.1	Peach	2.7	21	48:1	2.1
Lt Blue	2	15	64:1	1.5	Lt Blue	2	15	64:1	1.5
Purple	1.7	13	76:1	1.3	Purple	1.7	13	76:1	1.3
Lt Green	1.4	10	92:1	1	Lt Green	1.4	10	92:1	1
Orange	0.3	2.3	430:1	0.23	Orange	0.3	2.3	430:1	0.23
Lt Brown	0.2	1.5	640:1	0.15	Lt Brown	0.2	1.5	640:1	0.15

NOTE: The above chart is based upon the chemical viscosity of water (CPS = 1.0) and should only be used as a guide - the values were derived using water as the working fluid and 40 PSI (2.75 Bar) dynamic input pressure through a 50 ft (16 meter) hose. Actual ratios and flow rates may vary due to product viscosity, flow, pressure and tubing.

Tortuous Path Metering Device									
Part Number	Kit Desc.	Sanitizer							
		Flowrate	1 gallon	1 liter					
		oz/gal	ml./lit.	ratio	%				
2201221-05	1/2 Knuckle	1.00	7.9	126:1	0.79				
2201221-10	1 Knuckle	0.68	5.3	189:1	0.53				
2201221-15	1 1/2 Knuckles	0.51	4.0	252:1	0.40				
2201221-20	2 Knuckles	0.34	2.6	379:1	0.26				
2201221-25	2 1/2 Knuckles	0.27	2.1	473:1	0.21				
2201221-30	3 Knuckles	0.17	1.3	757:1	0.13				

NOTE: For a lower chemical ratio, Knight has a component called a "Tortuous Path Metering Device" available for very lean chemical mixes. The device connects in-line with the chemical supply and is used in place of a metering tip (no metering tip required). See the chart above for part ordering information.

Specification

Max Water Temperature

Min. 25°F (-3.9°C) Max. 150°F (65.6°C)

Foam Throw

30 PSI : 8ft -10ft 60 PSI : 8ft -10ft
(2 bar: 2.4m - 3m) (5.5 bar: 2.4m - 3m)

Operating Pressure

Min. 30 PSI (2 bar) Max. 80 PSI (5.5 bar)

Max Temperature of Blue PVC

Outside hose covering: 150°F (65.5°C)

Rinse and Sanitizer Flow rates (GPM)

Refer to Metering Tip Chart and Tortuous Path Metering Device Chart above.

ORDERING INFORMATION

DIAL-A-CHEM WALL MOUNT

PART #	DESCRIPTION
7649395	Dial-A-Chem hose end foamer with 25 ft. (7.6 m) reinforced hose and accessory kit
7649396	Dial-A-Chem hose end foamer with 50 ft. (15.2 m) reinforced hose and accessory kit
7649397	Dial-A-Chem hose end foamer with 100 ft. (30.4 m) reinforced hose and accessory kit
7649393	Accessory kit (ceramic tube weight for 3/8 OD tube, brass hose adapter (3/4" GHT), umbrella foot valve (viton), metering tip kit, hose clamp, mounting kit with screws and anchors, instructions, hose hanger bracket)

DIAL-A-CHEM MOBILE CART

PART #	DESCRIPTION
7649321	Dial-A-Chem Mobile Cart and accessory kit
DIAL-A-CHEM MOBILE CART OPTIONS	
7649390	Dial-A-Chem hose end foamer with 25 ft. (7.6 m) reinforced hose
7225942	Wire Rack for two 1 gallon round (D 6.250")(D 15.875 cm)
7225938	Wire Rack for two 1 Gallon F-Style (W 4.81" x L 7.06")(W 12.22 cm x L 17.93 cm)
7225931	Wire Rack for two 5 Liter Australian (W 5.56" x L 7.93")(W 14.12 cm x L 20.15 cm)
7225936	Wire Rack for two 2.5 Gallon F-Style (W 13.12" x L 9.12")(W 33.32 cm x L 23.16 cm)
7649255	Garden hose assembly

Dial-A-Chem Mobile Cart Dimensions

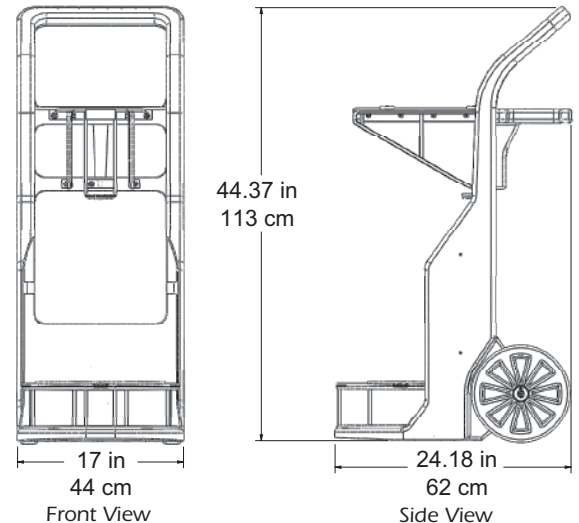

KNIGHT LIMITED WARRANTY

Knight controls and pump systems are warranted against defects in material and workmanship for a period of ONE YEAR. All Electronic Control Boards have a TWO YEAR warranty. Warranty applies only to the replacement or repair of such parts when returned to the factory with a KRA number, freight prepaid and found to be defective upon factory inspection. Rubber and synthetic rubber parts such as "O" rings, diaphragms, squeeze tubing and gaskets are considered expendable and are not covered under warranty. Warranty does not cover liability resulting from performance of this equipment nor the labor to replace this equipment. Product abuse or misuse voids warranty. Knight products are not for use in potentially explosive environments. Any use of our equipment in such an environment is at the risk of the user. Knight does not accept any liability in such circumstances.

KNIGHT DISCLAIMER

The information and specifications included in this publication were in effect at the time of approval for printing. Knight, LLC. reserves the right, however, to discontinue or change specifications or design at any time without notice and without incurring any obligation whatsoever.



Knight Headquarters
Toll Free (800)854-3764
Tel (949) 595-4800
Fax (949)595-4801
www.knightequip.com

Knight Canada
Tel (905)542-2333
Fax (905)542-1536

Knight Europe
Tel +44(1323)514.855
Fax +44(1323)514.828

Knight Australia
Tel +61(02)4223.7450
Fax +61(02)4271.8136

Knight N. Asia
Tel +82(2)3481.6683
Fax +82(2)3482.5742

Knight S. Asia
Tel +65.9170.0984
Fax +65.6489.6723